

Slinger.®

Slinger Bag

Battery Pack User Guide

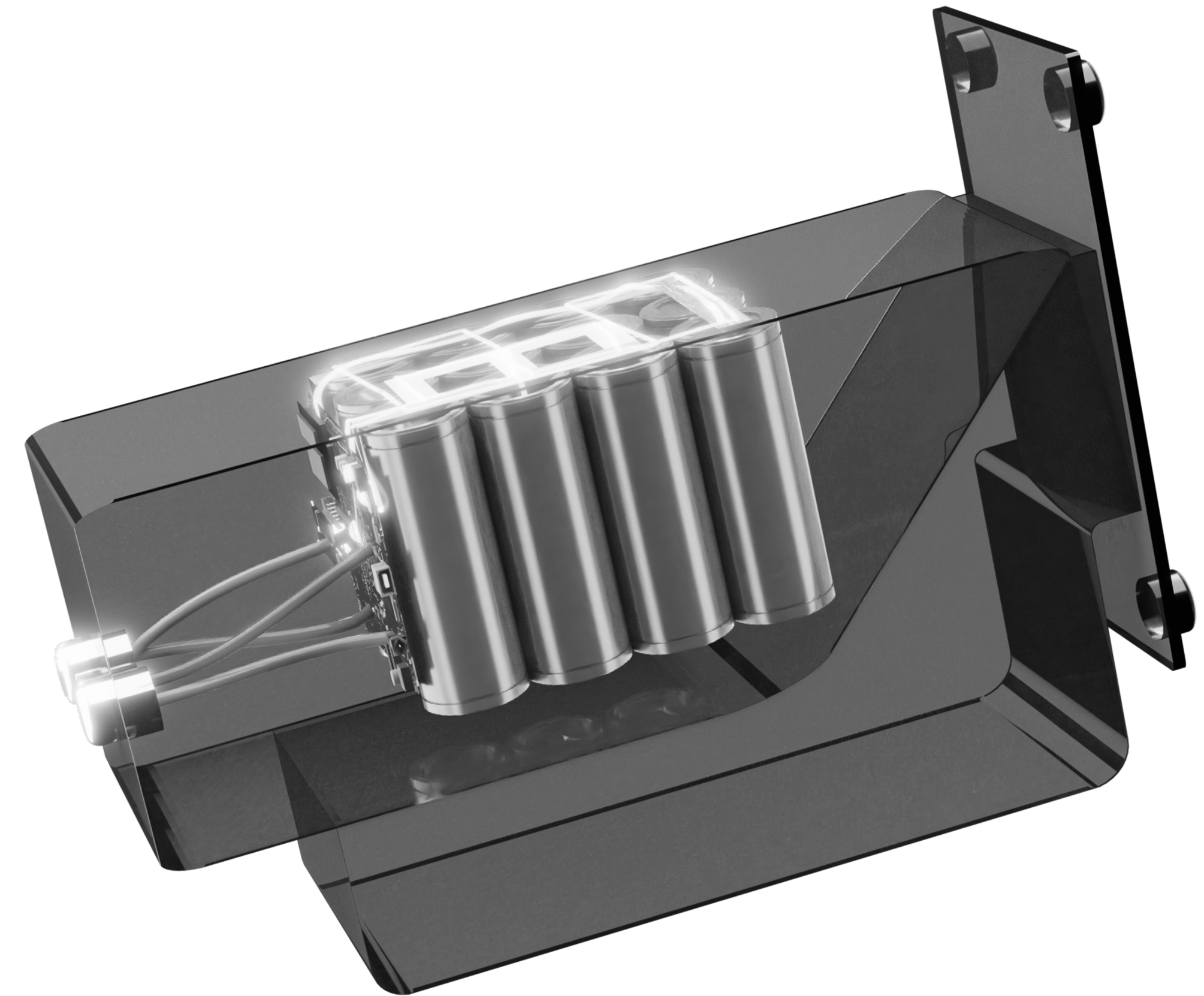

January, 2021

Getting The Best From Your Battery

We engineer ball launchers that are simple to use and easy to look after. But batteries contain complex chemical structures that react to their environment. We've put together some tips that will help you to get the maximum life from your battery.

- **Avoid use in extreme heat temperatures**

Hot environments speed up battery aging. So it's best to avoid using your launcher in extremely hot weather or leaving your launcher stored for long periods in rooms that experience direct sunlight for prolonged periods. The same goes for cold garages in winter.

- **Store your Slinger Bag Launcher at room temperature**

Heat sources, such as radiators, can damage the battery. We recommend that you store your Launcher battery at temperatures between 64°F–82°F (18°C–28°C), away from direct sunlight.

Getting The Best From Your Battery

- **Give it a break**

By letting the battery run down to empty at least once a month, you'll help to prolong its life. If you have a spare battery, we recommend you swap them out from time to time, so that they both have time to naturally discharge. Replacement batteries are available at [SlingerBag.com](https://www.slingerbagg.com).

- **Don't overcharge**

Avoid charging your battery overnight. The ideal charging time for an empty battery is around 5 hours. If you are charging a partially empty battery, make sure to unplug it from the power outlet as soon as you notice the charging indicator light has turned from red to green.

Following these basic battery safety guidelines will not only maximize your battery lifespan, but also keep you and your Slinger Bag safe.

Charging Your Battery

Depending on when you purchased your Slinger Bag, you will have either one or two options when recharging your battery.

- **Slinger Bag Launchers with serial numbers NOT beginning with the letter 'S'.**
Battery removal option is not available: please follow the 3-step battery charging instructions on page 5.
- **Slinger Bag Launchers with serial numbers beginning with the letter 'S'.**
Battery removal option is available. You may choose to either follow our 3-step battery charging instructions on page 5 or remove your battery following the steps on pages 6 and 7.



NOTE

If available with your model, we recommend you remove the battery to charge it, especially if you are not able to monitor your Slinger Bag during the 3-step charging option.

3-Step Battery Charging

This charging method is available to all Slinger Bag models.

Please follow the 3 steps outlined below:

Step 1



Locate the charger connector. You will find it on the bottom right side of your Slinger Bag settings panel.

Step 2



Plug power charger into the charger connector.

Red LED on Power Charger means battery is charging.

Green LED on Power Charger means battery is fully charged.

Step 3



When battery is fully charged (Green LED displayed) disconnect the charger cable.



WARNING

Make sure you switch your Slinger Bag off before charging it.

Removing Your Battery

This option is only available for models with serial numbers beginning with the letter 'S'.

Please follow the 7 steps outlined below:

Step 1



Unscrew four screws that fix battery drawer by hand.

Step 2

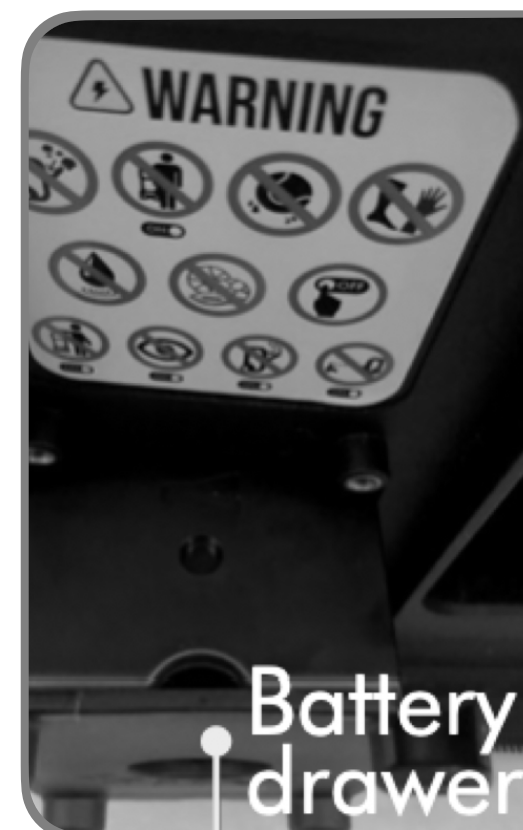

Slightly remove the battery drawer.

Step 3

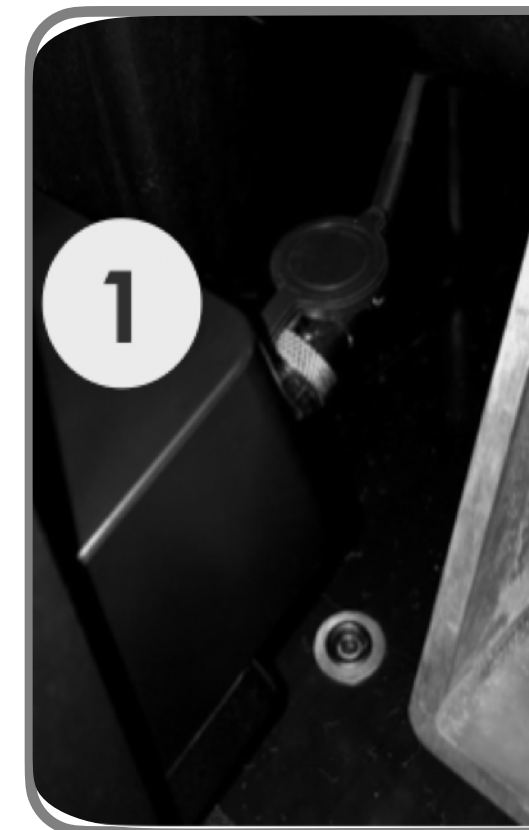

Disconnect the battery wire from the launcher connector.



NOTE

To avoid losing the screws, please screw them back into their holes or store the four screws at left / right pockets of bag.

Removing Your Battery (continued)

This option is only available for models with serial numbers beginning with the letter 'S'.

Step 4



Remove battery drawer. Open cover of charger connector.

Step 5



Plug power charger into the charger connector.

Red LED on Power Charger means battery is charging.

Green LED on Power Charger means battery is fully charged.

Step 6

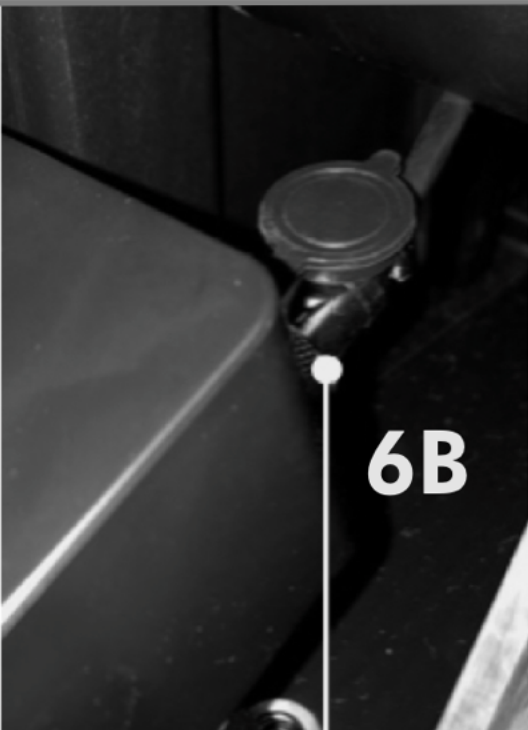
When fully charged disconnect the charger cable.

6A - Open the cover of launcher connector.

6B - Place battery drawer into launcher structure, connect battery cable and screw the connector tight.



Screw nut is not secure





Screw nut is secure



Step 7



Place battery drawer back into the battery housing structure. Screw in the four battery drawer screws and tighten by hand.

Frequently Asked Questions About Your Battery

1. Can I buy a replacement / spare battery ?

Yes, replacement batteries can be ordered at [SlingerBag.com](https://www.slingerbag.com)

2. My battery has no power ?

Check battery cable is correctly attached at back of battery (check step 6 on page 7). If the problem persists please contact support@slingerbag.com.

3. Storage during Winter months

Store your battery at room temperature to conserve its battery cells.

4. Can I charge my battery outside of the bag ?

Yes, in fact we recommend this method of charging and it allows you to store your battery separately from your Slinger Bag, protecting the battery from temperature extremes.

Frequently Asked Questions About Your Battery

5. What should I do with my old battery ?

Slinger products are made from high grade recyclable materials. The battery should be removed from the launcher before it's disposed of and recycled in accordance with local ordinances or regulations. If your battery needs replacing please visit www.slingerbag.com to purchase a replacement.

6. How long is my Slinger Battery life?

Lithium-ion batteries are built to last, with energy and power packed into a small area. Over time, all batteries are subject to degradation. So if your run time has declined when the launcher is in regular use, it might be time to buy a new battery.